

GET STARTED

1

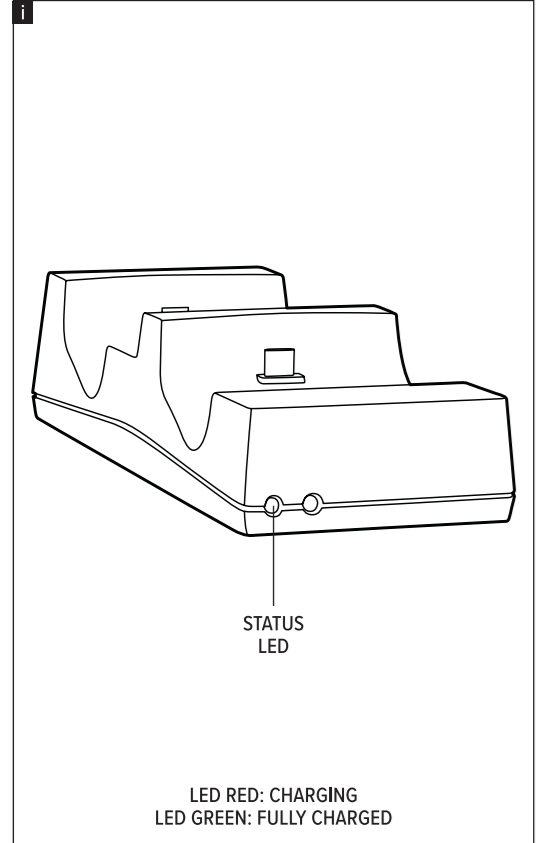

STATUS LED

LED RED: CHARGING
LED GREEN: FULLY CHARGED

EN

Technical support: www.speedlink.com
Safety instructions: www.speedlink.com

WEEE: Do not dispose of the product with household waste. Check your local waste disposal options and take to a recycling point. Improper storage/disposal may harm the environment and/or human health. Zeifracht Medien declares that the product conforms to the requirements listed under the 'conformity notice'.

INTENDED USE

This product is intended to be used as a controller charger for a video game console and is for indoor home/office use only. It contains no user-serviceable parts. Do not disassemble it and stop using it immediately if damaged. Zeifracht Medien GmbH accepts no liability whatsoever for any damage to this product or injuries caused due to careless or improper use or for purposes for which it is not intended.

Please keep this information for later reference.

DE

Technischer Support: www.speedlink.com
Sicherheitshinweise: www.speedlink.com

WEEE: Produkt nicht im Hausmüll entsorgen. Lokale Entsorgungsmöglichkeiten beachten und bei einer Recyclingstelle abgeben. Unsachgemäße Lagerung/Entsorgung kann der Umwelt und/oder Gesundheit schaden. Zeifracht Medien erklärt, dass das Produkt den unter 'conformity notice' (Konformitätshinweis) aufgeführten Anforderungen entspricht.

BESTIMMUNGSGEMÄSSER GEBRAUCH

Dieses Produkt dient als Controller-Ladegerät für eine Videospielekonsole für den Heim- oder Bürogebrauch in trockenen geschlossenen Räumen. Es ist wartungsfrei. Nicht öffnen oder bei Beschädigung nutzen. Die Zeifracht Medien GmbH übernimmt keine Haftung für Produktschäden oder Verletzungen von Personen durch unachtsame, unsachgemäße oder nicht dem angegebenen Zweck entsprechende Verwendung.

Bitte bewahren Sie diese Informationen zur künftigen Verwendung auf.

FR

Assistance technique: www.speedlink.com
Consignes de sécurité: www.speedlink.com

WEEE: Ne jetez pas le produit avec les ordures ménagères. Respectez les options d'élimination locales et déposez-le à un point de recyclage. Un stockage/une élimination inapproprié(e) peut nuire à l'environnement et/ou à la santé. Zeifracht Medien déclare que le produit est conforme aux exigences énumérées sous 'conformity notice' (Avis de conformité).

CADRE D'UTILISATION

Ce produit est destiné à servir de chargeur de manette pour une console de jeux vidéo à l'intérieur de locaux secs et fermés dans un cadre domestique ou de travail de bureau. Il ne demande pas d'entretien. Ne pas l'ouvrir et ne pas l'utiliser s'il est abîmé. La société Zeifracht Medien GmbH décline toute responsabilité en cas de dégradations du produit ou de blessures dues à une utilisation inconsidérée, incorrecte ou contraire à la destination indiquée.

Veuillez conserver ces informations afin de pouvoir vous y référer ultérieurement.

IT

Supporto tecnico: www.speedlink.com
Istruzioni di sicurezza: www.speedlink.com

WEEE: Non smaltire il prodotto con i rifiuti domestici. Attenersi alle opzioni di smaltimento locali e conferire a una piattaforma di riciclaggio. Lo stoccaggio/smaltimento improprio può danneggiare l'ambiente e/o la salute. Zeifracht Medien dichiara che il prodotto è conforme ai requisiti elencati nell' 'conformity notice' (Avviso di conformità).

USO CONFORME ALLA DESTINAZIONE

Questo prodotto serve come caricatore per controller per una console per videogiochi per uso domestico o in ufficio, in ambienti asciutti e chiusi. Il prodotto non richiede manutenzione. Non aprire o usare in caso di danneggiamenti. La Zeifracht Medien GmbH non risponde di danni al prodotto o lesioni personali a seguito di un uso

negligente, improprio o non conforme all'uso indicato.

Si prega di conservare queste informazioni per poterle utilizzare come riferimento in futuro.

ES

Soporte técnico: www.speedlink.com
Instrucciones de seguridad: www.speedlink.com

WEEE: No deseches el producto con la basura doméstica. Tenga en cuenta las opciones locales de eliminación y entréguelo en un punto de reciclaje. El almacenamiento/eliminación inadecuados pueden dañar el medio ambiente y/o la salud. Zeifracht Medien declara que el producto cumple con los requisitos enumerados en el 'conformity notice' (Aviso de conformidad).

USO SEGÚN INSTRUCCIONES

Este producto sirve como controlador del cargador de una consola de videojuegos para ser usado en hogares u oficinas y en espacios secos y cerrados. No necesita mantenimiento. No abrir ni utilizar si presenta daños o defectos. Zeifracht Medien GmbH no asume la responsabilidad por daños en el producto o lesiones corporales ocasionadas por una utilización inadecuada o impropia, diferente de la recomendada.

Conserve esta información para consultarla en el futuro.

TR

Teknik Destek: www.speedlink.com
Güvenlik Bilgileri: www.speedlink.com

WEEE: Ürünü ev atıklarına atmayın. Yerel bertaraf seçeneplerine dikkat edin ve bir geri dönüşüm noktasına teslim edin. Uygunsuz saklanması/bertarafı çevreye ve/veya sağlığa zararlıdır. Zeifracht Medien, ürünün 'conformity notice' (uygunluk beyanı) altında belirtilen standartlara uygun olduğunu beyan eder.

KULLANIM AMACI

Bu ürün, kuru, kapalı bir alanda ev veya ofis kullanımını için bir video oyun konsolu için kontrolör şarj cihazı görevi görür. Bakım gerek-

tirmez. Açmayın veya hasarlıysa kullanmayın. Zeifracht Medien GmbH, dikkatsiz ve uygunsuz kullanım veya belirtilen amaca uygun olmayan kullanımdan kaynaklanan ürün hasarı veya kişisel yaralanma için hiçbir sorumluluk kabul etmez.

Lütfen bu bilgileri ileride başvurmak üzere saklayın.

RU

Техническая поддержка: www.speedlink.com
Указания по безопасности: www.speedlink.com

WEEE: Не выбрасывайте изделие вместе с бытовыми отходами. Изучите варианты утилизации и сдайте его в пункт утилизации. Неправильное хранение/утилизация может нанести вред окружающей среде и/или здоровью. Zeifracht Medien подтверждает, что продукт соответствует требованиям, перечисленным в разделе 'conformity notice' (Уведомление о соответствии).

ИСПОЛЬЗОВАНИЕ ПО НАЗНАЧЕНИЮ

Это изделие предназначено только для использования в качестве устройства для зарядки контроллеров дома или в офисе в сухих, закрытых помещениях. Оно не нуждается в техническом обслуживании. Не открывать и не использовать, если оно повреждено. Zeifracht Medien GmbH не несет ответственности за ущерб изделию или травмы лиц вследствие неосторожного, ненадлежащего, или не соответствующего указанной цели использования.

Сохраните эту информацию для использования в будущем.

NL

Technische ondersteuning: www.speedlink.com
Waarschuwingen: www.speedlink.com

WEEE: Gooi het product niet weg met het huisvuil. Houd rekening met de plaatselijke procedures voor afvalverwerking en lever deze in bij een recyclingpunt. Onjuiste opslag/verwijdering kan schadelijk zijn voor het milieu en/of de gezondheid. Zeifracht Medien verklaart dat het product voldoet aan de voorwaarden zoals vermeld onder de 'conformity notice' (Conformiteitsverklaring).

Bezoek de website www.speedlink.com voor meer informatie over het product.

BEDOELD GEBRUIK

Dit product is bedoeld als oplader voor controllers van gameconsoles en voor gebruik thuis of op kantoor, meer bepaald in droge binnenruimtes. Het is onderhoudsvrij. Maak het niet open en gebruik het niet als het beschadigd is. Zeifracht Medien GmbH is niet aansprakelijk voor schade aan het product of persoonlijk letsel als gevolg van ondoordacht of ondeskundig gebruik, of gebruik dat niet in overeenstemming is met het aangegeven doel.

Bewaar deze informatie voor toekomstige naslag.

PL

Pomoc techniczna: www.speedlink.com
Wskazówki bezpieczeństwa: www.speedlink.com

WEEE: nie wyrzucaj produktu wraz z odpadami domowymi. Przestrzegaj lokalnych możliwości utylizacji i oddaj produkt do punktu recyklingu. Niewłaściwe przechowywanie/utylizacja może szkodzić środowisku i/lub zdrowiu. Zeifracht Medien potwierdza, że produkt jest zgodny z wymaganiami wymienionymi w 'conformity notice' (Informacji o zgodności).

UŻYTKOWANIE ZGODNE Z PRZYZNACZENIEM

Ten produkt to ładowarka do kontrolera konsoli do gier wideo do użytku w domu lub w biurze, w suchych, zamkniętych pomieszczeniach. Nie wymaga on konserwacji. Nie otwieraj ani nie korzystaj z niego w razie uszkodzenia. Zeifracht Medien GmbH nie ponosi żadnej odpowiedzialności za uszkodzenia produktu lub obrażenia u ludzi spowodowane niewłaźnym, nieodpowiednim lub niezgodnym z przeznaczeniem użytkowaniem produktu.

Prosimy zachować tę informację do późniejszego wykorzystania.

HU

Műszaki támogatás: www.speedlink.com
Tudnivalók: www.speedlink.com

WEEE: Ne dobja a terméket a háztartási hulladék közé. Vegye figyelembe a helyi hulladékkezelési lehetőségeket, és terméket adja le egy újrahasznosítási helyen. A nem megfelelő tárolás/megsemmisítés károsíthatja a környezetet és/vagy az egészséget. A Zeifracht Medien kijelenti, hogy a termék

megfelel a 'conformity notice' (Megfelelőségi nyilatkozat) részben felsorolt követelményeknek.

RENDELTESSZERŰ HASZNÁLAT

Ez a termék otthoni vagy irodai környezetben, száraz, zárt térben videó játékkonzolhoz, kontrollerek töltőkészülékéként használható. Nem igényel karbantartást. Ne nyissa fel és károsodás esetén ne használja. A Zeifracht Medien GmbH nem vállal felelősséget a termék károsodásaiért és személyi sérülésekért, ha gondatlan, szakszerűtlen vagy nem a célnak megfelelő használatból ered.

Kérem, ezt az információt tartsa meg referenciaként.

GR

Τεχνική υποστήριξη: www.speedlink.com
Υποδείξεις ασφαλείας: www.speedlink.com

WEEE: Μην απορρίπτετε το προϊόν μαζί με τα οικιακά απόβλητα. Ενημερωθείτε για τις τοπικές δυνατότητες απόρριψης και παραδώστε το σε ένα σημείο ανακύκλωσης. Η ακατάλληλη αποθήκευση/απόρριψη μπορεί να προκαλέσει βλάβες στο περιβάλλον ή/και την υγεία. Η Zeifracht Medien δηλώνει ότι το προϊόν συμμορφώνεται με τις απαιτήσεις της ενότητας 'conformity notice' (ειδοποίηση συμμόρφωσης).

ΧΡΗΣΗ ΣΥΜΦΩΝΗ ΜΕ ΤΟΥΣ ΚΑΝΟΝΙΣΜΟΥΣ

Αυτό το προϊόν λειτουργεί ως ασυρματική φόρτιξη ελεγκτή κονσόλας βιντεοπαιχνιδιών για οικιακή χρήση ή χρήση σε γραφείο σε ξηρούς, κλειστούς χώρους. Δεν απαιτεί συντήρηση. Μην ανοίγετε ή μη χρησιμοποιείτε σε περίπτωση ζημιάς. Η Zeifracht Medien GmbH δεν αναλαμβάνει καμία ευθύνη για ζημιές στο προϊόν ή για τραυματισμούς ατόμων λόγω απρόσεκτης, ακατάλληλης χρήσης ή χρήσης του προϊόντος για διαφορετικό σκοπό από τον αναφερόμενο.

Παρακαλούμε φυλάξτε αυτές τις πληροφορίες για μελλοντική αναφορά.

CZ

Technický suport: www.speedlink.com
Bezpečnostní upozornění: www.speedlink.com

WEEE: Ne vyhazujte výrobek do domovního odpadu. Dodržujte místní možnosti likvidace a odevzdejte v místě recyklace. Nesprávné skladování/likvidace může poškodit životní prostředí a/nebo zdraví. Zeifracht Medien prohlašuje, že produkt splňuje požadavky uvedené v části 'conformity notice' (Oznámení o shodě).

WEEE: Výrobek nevyhazujte do domovního odpadu. Dodržujte místní možnosti likvidace a odevzdejte v místě recyklace. Nesprávné skladování/likvidace může poškodit životní prostředí a/nebo zdraví. Zeifracht Medien prohlašuje, že produkt splňuje požadavky uvedené v části 'conformity notice' (Oznámení o shodě).

POUŽITÍ DLE PŘEDPISŮ

Tento výrobek se používá jako nabíječka controlleru pro konzolu videohry pro domácí nebo kancelářské použití v suchých, uzavřených prostorách. Je bezúdržbový. Neotevírá ani nepoužívá v případě poškození. Firma Zeifracht Medien GmbH nepřebírá ručení za poškození výrobku nebo zranění osob z důvodu neopatrného, neodborného použití, nebo z důvodu použití výrobku za jiným účelem, než který byl uveden.

Tyto informace uchovejte pro budoucí potřebu.

PT

Suporte técnico: www.speedlink.com
Avisos de segurança: www.speedlink.com

WEEE: Não eliminar o produto no lixo doméstico. Prestar atenção às opções locais de eliminação e deixar num ponto de reciclagem. O armazenamento/eliminação inadequados podem prejudicar o ambiente e/ou a saúde. A Zeifracht Medien declara que o produto está em conformidade com os requisitos que constam no 'conformity notice' (Aviso de conformidade).

UTILIZAÇÃO SEGUNDO AS NORMAS

Este produto deve ser utilizado como carregador para Controller de uma consola de jogos para o lar ou escritório em espaços secos e fechados. Não necessita manutenção. Não abrir ou utilizar em caso de danos e defeitos. A Zeifracht Medien GmbH não é responsável por danos no produto ou ferimentos pessoais devido ao uso descuidado, impróprio ou não de acordo com o propósito declarado.

Por favor, guarde esta informação para uma futura referência.

DK

Teknisk support: www.speedlink.com

Sikkerhedsanvisninger: www.speedlink.com

WEEE: Smid ikke produktet i husholdningsaffaldet. Overhold lokale bortskaftelsesmuligheder og aflever på et genbrugssted. Forkert opbevaring/bortskaffelse kan skade miljøet og/eller sundheden. Zeifracht Medien erklærer, at produktet er i overensstemmelse med kravene anført under 'conformity notice' (Konformitetsmeddelelse).

KORREKT ANVENDELSE

Dette produkt er beregnet til anvendelse som controller-oplader til brug i private hjem eller på kontorer i tørre, lukkede rum. Det er vedligeholdelsesfrit. Må ikke åbnes eller bruges, hvis det er beskadiget. Zeifracht Medien GmbH giver ikke garanti for skader på produktet eller personskader, som er forårsaget af uagtsom, uhensigtsmæssig eller forkert anvendelse eller anvendelse, som ikke er i overensstemmelse med det angivne formål.

Du bedes opbevare disse informationer til senere brug.

SE

Teknisk support: www.speedlink.com
Säkerhetsanvisningar: www.speedlink.com

WEEE: Släng inte produkten i hushållsavfallet. Observera avfallshanteringsföreskrifter och lämna in på en återvinningsstation. Felaktig lagring/avfallshantering kan skada miljön och/eller hälsan. Zeifracht Medien intygar att produkten överensstämmer med de krav som anges under 'conformity notice' (meddelande om överensstämmelse).

FÖRESKRIVEN ANVÄNDNING

Den här produkten ska användas som kontrolladdare i torra utrymmen inomhus och anslutas till en videospelkonsol i hemmet eller på kontoret. Produkten är underhållsfri. Försök inte öppna produkten och använd den inte om den är skadad. Zeifracht Medien GmbH ansvarar inte för några skador på produkten eller personskador som är ett resultat av oaksamhet, felaktig behandling eller för att produkten använts i andra syften än de som specificeras av tillverkaren. Spara den här informationen för senare bruk.

NO

Teknisk support: www.speedlink.com
Sikkerhetsinformasjon: www.speedlink.com

WEEE: Ikke kast produktet i vanlig husholdningsavfall. Vær oppmerksom på lokale avhendingsalternativer og avlever på en gjenvinningsstasjon. Uriktig lagring/avhending kan skade miljøet og/eller helsen. Zeifracht Medien erklærer at produktet oppfyller kravene oppført under 'conformity notice' (samsvarsvarsel).

FORSKRIFTMESSIG BRUK

Dette produktet tjener som controller-ladeapparat for en videospillkonsoll til bruk hjemme eller på kontoret i tørre lukkede rom. Produktet er vedlikeholdsfritt. Ikke forsøk å åpne produktet, og ikke bruk det hvis det er skadet. Zeifracht Medien GmbH kan ikke holdes ansvarlig for produkt- eller personskader som skyldes at produktet er brukt på en uaktsom eller ikke-forskriftsmessig måte, eller til andre formål enn det som er tiltenkt.

Vennligst oppvear denne informasjonen for senere referanse.

FI

Tekninen tuki: www.speedlink.com
Turvaohjeet: www.speedlink.com

WEEE: Älä hävitä tuotetta kotitalousjätteen mukana. Huomioi paikalliset hävitysmahdollisuudet ja toimita kierrätyspisteeseen. Väärä varastointi/hävittäminen voi vahingoittaa ympäristöä ja/tai terveyttä. Zeifracht Medien vakuuttaa, että tuote on kohdassa 'conformity notice' (Vaatumustenmukaisuusilmoitus) luettujen vaatimusten mukainen.

MÄÄRÄYSTENMUKAINEN KÄYTTÖ

Tämä tuote on tarkoitettu videopelikonsolin ohjaimen laturiksi koti- tai toimistokäytössä kuivissa ja suljetuissa tiloissa. Tuotetta ei tarvitse huoltaa. Ei saa avata tai käyttää, jos se on vahingoittunut. Zeifracht Medien GmbH ei ota minkäänlaista vastuuta tuotevaurioista tai henkilöiden loukkaantumisista, jotka johtuvat tuotteen huolimattomasta, asiattomasta tai ilmoitetusta käyttötarkoituksesta poikkeavasta käytöstä.



www.speedlink.com



Sällytä nämä tiedot myöhempää käyttöä varten.

RO

Asistență tehnică: www.speedlink.com

Indicații de siguranță: www.speedlink.com

 WEEE: Nu aruncați produsul la gunoiul menajer. Respectați opțiunile locale de eliminare și predați la un centru de reciclare. Depozitarea/eliminarea necorespunzătoare poate dăuna mediului și/sau sănătății. Zeifracht Medien declară că produsul respectă cerințele enumerate în 'conformity notice' (Declarație de conformitate).

UTILIZARE CONFORMĂ

Acest produs este adecvat numai ca și încărcător controller pentru o consolă de jocuri video pentru uz domestic sau pentru birou, în spații închise și uscate. Produsul nu necesită întreținere. A nu se deschide și a nu se folosi dacă prezintă daune. Compania Zeifracht Medien GmbH nu își asumă răspunderea pentru deteriorări ale produsului sau vătămări corporale cauzate de utilizarea neatentă, necorespunzătoare sau neconformă destinației produsului, indicate de producător.

Vă rugăm să păstrați aceste informații pentru a le putea consulta ulterior.

HR

Tehnička podrška: www.speedlink.com

Sigurnosne napomene: www.speedlink.com

 WEEE: Ne bacajte proizvod u kućni otpad. Obratite pažnju na lokalne mogućnosti zbrinjavanja i odnesite na mjesto za recikliranje. Nepravilno skladištenje/odlaganje može naštetiti okolišu i/ili zdravlju. Zeifracht Medien izvjavljuje da je proizvod uskladen sa zahtjevima navedenima 'conformity notice' (Obavijesti o skladnosti).

NAMJENSKA UPORABA

Ovaj proizvod služi kao punjač za igraću konzolu za uporabu u domaćinstvu ili uredu u suhim i zatvorenim prostorima. Proizvod ne zahtijeva održavanje. Ne otvarajte i koristiti ako je oštećen. Tvrtka Zeifracht Medien GmbH ne preuzima nikakvu

odgovornost za štete na proizvodu ili ozljede nastale nepažljivo i nenamjenskom uporabom, ili uporabom koja nije u skladu s navedenom svrhom proizvoda.

Molimo Vas sačuvajte ove informacije za buduću uporabu.

RS

Tehnička podrška: www.speedlink.com

Sigurnosne napomene: www.speedlink.com

 WEEE: Ne odlažite proizvod u kućni otpad. Obratite pažnju na lokalne mogućnosti odlaganja i predajte ga na reciklažnom mestu. Nepravilno skladištenje/odlaganje može imati štetne posledice za životnu sredinu i/ili zdravlje. Zeifracht izvjavljuje da je proizvod uskladen sa zahtjevima navedenim u odeljku „Conformity notice“.

NAMENSKA UPOTREBA

Ovaj proizvod služi kao controller-punjač za konzolu za videoigre za upotrebu u kući ili kancelariji u suvim, zatvorenim prostorijama. Nije potrebno održavanje. Nemojte otvarati ili koristiti ako je oštećen. Preduzeće Zeifracht Medien GmbH ne preuzima odgovornost za štete na proizvodu ili povrede osoba usled nepažljive i nestručne primene ili usled korišćenja koje nije u skladu s navedenom svrhom.

Sačuvajte ove informacije za kasniju upotrebu.

SI

Tehnična podpora: www.speedlink.com

Varnostna navodila: www.speedlink.com

 WEEE: Izdelka ne odvrzite med gospodinjske odpadke. Upoštevajte lokalne možnosti odstranjevanja in izdelek oddajte na reciklažno mesto. Nepravilno shranjevanje/odlaganje lahko škoduje okolju in/ali zdravju. Zeifracht Medien izvjavlja, da je izdelek v skladu z zahtevami, ki so navedene v 'conformity notice' (Obvestilu o skladnosti).

PREDVIDENA UPORABA

Ta izdelek se uporablja kot polnilnik za upravljalnik za priključitev na igralno konzolo v suhih, zaprtih prostorih v domačem gospodinjstvu

ali pisarni. Izdelka ni treba vzdrževati. Izdelka ne odpirajte in ga ne uporabljajte poškodovanega. Družba Zeifracht Medien GmbH ne prevzema nikakršne odgovornosti za škodo na izdelku ali telesne poškodbe oseb na podlagi nepažljive, neustrezne uporabe izdelka ali njegove uporabe za namene, ki ne ustrezajo navedbam proizvajalca o ustreznih uporabi izdelka.

Prosimo vas, da te informacije shranite za prihodnjo rabo.

EE

Tehniline tugi: www.speedlink.com

Ohutusõudud: www.speedlink.com

 WEEE: Mitte visata toodet olmejäätmete hulka. Arvestage kohalike jäätmeäitlusvõimalustega ja viige jäätmed ringlussevõutupunkti. Ebaõige ladustamine/käitlemine võib kahjustada keskkonda ja/või tervist. Zeifracht Medien kinnitab, et toode vastab jaotises 'conformity notice' (Vastavusdeklaratsioon) loetletud nõuetele.

NÕUETEKOHANE KASUTAMINE

See toode on videomängude konsooli kontrolleri laadija, mis on ette nähtud kasutamiseks koduses ja büroodes kuivade ja suletud ruumide puhul. Seade on hooldevala. Seadet ei tohi avada ega selle kahjustuste korral kasutada. Zeifracht Medien GmbH ei võta vastutust hooletust, asjatundmatust või mitteametlikust kasutamisest tingitud inimvigastuste või varakahjude eest.

Sällitage see infoleht tulevaseks kasutamiseks.

EG

قسم الدعم الفني: www.speedlink.com

إرشادات السلامة: www.speedlink.com

 WEEE: لا تتخلص من المنتج مع النفايات المنزلية. راقب الخيارات المطبقة محلياً للتخلص من النفايات وقم بتسليمها إلى نقطة إعادة التدوير. التخزين غير المناسب أو التخلص من المنتج بطريقة خاطئة يمكن أن يضر بالبيئة وأو الصحة.

تعلن Zeifracht Medien أن المنتج يتوافق مع المتطلبات المدرجة ضمن 'conformity notice'، «إشعار المطابقة».

الاستخدام المطابق للتعليمات

هذا المنتج عبارة عن شاحن متحكم كونسول ألعاب الفيديو للاستخدام المنزلي أو المكتبي في غرف مغلقة جافة. وهو لا يحتاج للصيانة. لا تفتحه ولا تستخدمه حال تعرضه للضرر. لا تتحمل شركة Zeifracht Medien GmbH أية مسؤولية عن أضرار المنتجات أو تعرض الأفراد للإصابة بسبب الاستخدام غير الواعي أو غير المطابق للتعليمات أو غير المطابق لغرض الاستخدام المقرر.

. برجاء الاحتفاظ بهذه المعلومات من أجل استخدامها في وقت لاحق.

IL

המיכה טכנית: www.speedlink.com

הוראות בטיחות: www.speedlink.com

 WEEE: אין להשליך את המוצר לאשפה הביתית. יש לברר את אפשרויות הסילוק המקומיות ולמסור אותו לנקודת מיחזור אחסון/סילוק בלתי ראויים עלולים לגרום נזק לסביבה ו/או לבריאות.

Zeifracht Medien מצהירה שהמוצר עומד בדרישות המפורטות ב-**'conformity notice'** (הודעת התאמת).

שימוש על פי היעוד

מוצר זה משמש כמטען בקר עבור קונסולת משחקי וידאו לשימוש ביתי או משרדי בחדרים פנימיים ויבשים. אין צורך בתחזוקה של המכשיר אין לפתוח את המכשיר ואין להשתמש במכשיר פגום. חברת Zeifracht Medien GmbH אינה אחראית לנזקים במוצר או לפגיעות נזק, הנגרמים על ידי שימוש לא זהיר, לא מתאים, או למסרות שונות מהמטרה המיועדת.

אנא שמור מידע זה לשימוש עתידי.

BG

Техническа поддръжка: www.speedlink.com

Указания за безопасност: www.speedlink.com

 WEEE: Не изхвърляйте продукта с битовите отпадъци. Съблюдавайте местните възможности за изхвърляне и предайте в пункт за рециклиране. Неправилното съхранение/изхвърляне може да навреди на околната среда и/или здравето. Zeifracht Medien декларира, че продуктът отговаря на изискванията, посочени в 'conformity notice' (Известие за съответствие).

УПОТРЕБА ПО ПРЕДНАЗНАЧЕНИЕ

Този продукт служи като зарядно устройство за контролер

за конзола за видео игри за домашна или офис употреба в сухи, затворени помещения. Той не се нуждае от поддръжка. Не отваряйте и не използвайте при повреда. Фирма Zeifracht Medien GmbH не поема отговорност за повреди на продукта или наранявания на лица в резултат на невнимателна, неправилна или несъответстваща на посоченото предназначение употреба.

Моля, запазете тази информация за бъдеща употреба.

SK

Technická podpora: www.speedlink.com

Bezpečnostné pokyny: www.speedlink.com

 WEEE: Nevyhadzujte produkt do domového odpadu. Venujte pozornost miestnym možnostiam likvidácie a odovzdajte produkt v recyklačnom stredisku. Neodborné skladovanie/ neodborná likvidácia môže poškodiť životné prostredie a/alebo zdravie. Spoločnosť Zeifracht Medien vyhlasuje, že produkt zodpovedá požiadavkám, ktoré sú uvedené v 'conformity notice' (oznámenie o zhode).

POUŽÍVANIE NA URČENÝ ÚČEL

Tento produkt slúži ako controller nabíjačka pre hernú videokonzolu pre domáce alebo kancelárske použitie v suchých, uzatvorených miestach. Nevyžaduje údržbu. Neotvárajte ani pro poškodení nepoužívajte. Spoločnosť Zeifracht Medien GmbH nepreberá žiadne ručenie za škody na produktoch alebo poranenia osôb v dôsledku neopatrného, neodborného používania alebo používania nezodpovedajúceho uvedenému účelu.

Túto informáciu uchovajte, prosím, pre budúce použitie.

SAFETY INSTRUCTIONS

IMPORTANT SAFETY INSTRUCTIONS

 Please note that the failure to observe these instructions can cause product damage, explosion, fire and/or electric shocks!

- Only use this device as indicated in the user guide. Do not open or repair it.
- Do not expose the device to liquids, heat or cold.
- Do not use the device in a damp environment. Clean the device with a dry cloth.
- Keep the device and all loose parts away from children, pets and unauthorized persons.
- Only use the devices with the appropriate provided accessories/cables.
- Disconnect the charging cable from the device if it will not be used for a long time. When disconnecting the cable, don't pull on the cord but on the plug.
- Don't use the cables in any way other than mentioned in the user guide; don't bend, cut, extend, knot or step on them.
- Do not insert any foreign objects into the openings of the device.
- If the device is damaged in any way or gets too hot, stop using it immediately.
- Take caution when using the device if you have a pacemaker or are dependent on other sensitive electronic life aids, as the device emits radio signals.

Safety instructions in further languages: www.speedlink.com

WICHTIGE SICHERHEITSHINWEISE

Die Nichtbeachtung dieser Hinweise kann zu Schäden am Produkt, Explosionen, Feuer oder elektrischen Schocks führen!

CONFORMITY NOTICE

Operation of the device (the devices) may be affected by strong static, electrical or high-frequency fields (radio installations, mobile telephones, microwaves, electrostatic discharges). If this occurs, try increasing the distance from the devices causing the interference.

Conformity notice in further languages: www.speedlink.com

WARNING SYMBOLS AND MARKINGS

CONFORMITY NOTICE

Operation of the device (the devices) may be affected by strong static, electrical or high-frequency fields (radio installations, mobile telephones, microwaves, electrostatic discharges). If this occurs, try increasing the distance from the devices causing the interference.

CONFORMITY NOTICE

Operation of the device (the devices) may be affected by strong static, electrical or high-frequency fields (radio installations, mobile telephones, microwaves, electrostatic discharges). If this occurs, try increasing the distance from the devices causing the interference.

CONFORMITY NOTICE

Operation of the device (the devices) may be affected by strong static, electrical or high-frequency fields (radio installations, mobile telephones, microwaves, electrostatic discharges). If this occurs, try increasing the distance from the devices causing the interference.

CONFORMITY NOTICE

Operation of the device (the devices) may be affected by strong static, electrical or high-frequency fields (radio installations, mobile telephones, microwaves, electrostatic discharges). If this occurs, try increasing the distance from the devices causing the interference.

CONFORMITY NOTICE

Operation of the device (the devices) may be affected by strong static, electrical or high-frequency fields (radio installations, mobile telephones, microwaves, electrostatic discharges). If this occurs, try increasing the distance from the devices causing the interference.

CONFORMITY NOTICE

Operation of the device (the devices) may be affected by strong static, electrical or high-frequency fields (radio installations, mobile telephones, microwaves, electrostatic discharges). If this occurs, try increasing the distance from the devices causing the interference.

CONFORMITY NOTICE

Operation of the device (the devices) may be affected by strong static, electrical or high-frequency fields (radio installations, mobile telephones, microwaves, electrostatic discharges). If this occurs, try increasing the distance from the devices causing the interference.

CONFORMITY NOTICE

Operation of the device (the devices) may be affected by strong static, electrical or high-frequency fields (radio installations, mobile telephones, microwaves, electrostatic discharges). If this occurs, try increasing the distance from the devices causing the interference.

CONFORMITY NOTICE

Operation of the device (the devices) may be affected by strong static, electrical or high-frequency fields (radio installations, mobile telephones, microwaves, electrostatic discharges). If this occurs, try increasing the distance from the devices causing the interference.

CONFORMITY NOTICE

Operation of the device (the devices) may be affected by strong static, electrical or high-frequency fields (radio installations, mobile telephones, microwaves, electrostatic discharges). If this occurs, try increasing the distance from the devices causing the interference.

CONFORMITY NOTICE

Operation of the device (the devices) may be affected by strong static, electrical or high-frequency fields (radio installations, mobile telephones, microwaves, electrostatic discharges). If this occurs, try increasing the distance from the devices causing the interference.

CONFORMITY NOTICE

Operation of the device (the devices) may be affected by strong static, electrical or high-frequency fields (radio installations, mobile telephones, microwaves, electrostatic discharges). If this occurs, try increasing the distance from the devices causing the interference.

CONFORMITY NOTICE

Operation of the device (the devices) may be affected by strong static, electrical or high-frequency fields (radio installations, mobile telephones, microwaves, electrostatic discharges). If this occurs, try increasing the distance from the devices causing the interference.

CONFORMITY NOTICE

Operation of the device (the devices) may be affected by strong static, electrical or high-frequency fields (radio installations, mobile telephones, microwaves, electrostatic discharges). If this occurs, try increasing the distance from the devices causing the interference.

CONFORMITY NOTICE

Operation of the device (the devices) may be affected by strong static, electrical or high-frequency fields (radio installations, mobile telephones, microwaves, electrostatic discharges). If this occurs, try increasing the distance from the devices causing the interference.

WARNING SYMBOLS AND MARKINGS

CONFORMITY NOTICE

Operation of the device (the devices) may be affected by strong static, electrical or high-frequency fields (radio installations, mobile telephones, microwaves, electrostatic discharges). If this occurs, try increasing the distance from the devices causing the interference.

CONFORMITY NOTICE

Operation of the device (the devices) may be affected by strong static, electrical or high-frequency fields (radio installations, mobile telephones, microwaves, electrostatic discharges). If this occurs, try increasing the distance from the devices causing the interference.

CONFORMITY NOTICE

Operation of the device (the devices) may be affected by strong static, electrical or high-frequency fields (radio installations, mobile telephones, microwaves, electrostatic discharges). If this occurs, try increasing the distance from the devices causing the interference.

CONFORMITY NOTICE

Operation of the device (the devices) may be affected by strong static, electrical or high-frequency fields (radio installations, mobile telephones, microwaves, electrostatic discharges). If this occurs, try increasing the distance from the devices causing the interference.

CONFORMITY NOTICE

Operation of the device (the devices) may be affected by strong static, electrical or high-frequency fields (radio installations, mobile telephones, microwaves, electrostatic discharges). If this occurs, try increasing the distance from the devices causing the interference.

CONFORMITY NOTICE

Operation of the device (the devices) may be affected by strong static, electrical or high-frequency fields (radio installations, mobile telephones, microwaves, electrostatic discharges). If this occurs, try increasing the distance from the devices causing the interference.

CONFORMITY NOTICE

Operation of the device (the devices) may be affected by strong static, electrical or high-frequency fields (radio installations, mobile telephones, microwaves, electrostatic discharges). If this occurs, try increasing the distance from the devices causing the interference.

CONFORMITY NOTICE

Operation of the device (the devices) may be affected by strong static, electrical or high-frequency fields (radio installations, mobile telephones, microwaves, electrostatic discharges). If this occurs, try increasing the distance from the devices causing the interference.

CONFORMITY NOTICE

Operation of the device (the devices) may be affected by strong static, electrical or high-frequency fields (radio installations, mobile telephones, microwaves, electrostatic discharges). If this occurs, try increasing the distance from the devices causing the interference.

CONFORMITY NOTICE

Operation of the device (the devices) may be affected by strong static, electrical or high-frequency fields (radio installations, mobile telephones, microwaves, electrostatic discharges). If this occurs, try increasing the distance from the devices causing the interference.

CONFORMITY NOTICE

Operation of the device (the devices) may be affected by strong static, electrical or high-frequency fields (radio installations, mobile telephones, microwaves, electrostatic discharges). If this occurs, try increasing the distance from the devices causing the interference.

CONFORMITY NOTICE

Operation of the device (the devices) may be affected by strong static, electrical or high-frequency fields (radio installations, mobile telephones, microwaves, electrostatic discharges). If this occurs, try increasing the distance from the devices causing the interference.

CONFORMITY NOTICE

Operation of the device (the devices) may be affected by strong static, electrical or high-frequency fields (radio installations, mobile telephones, microwaves, electrostatic discharges). If this occurs, try increasing the distance from the devices causing the interference.

CONFORMITY NOTICE

Operation of the device (the devices) may be affected by strong static, electrical or high-frequency fields (radio installations, mobile telephones, microwaves, electrostatic discharges). If this occurs, try increasing the distance from the devices causing the interference.

CONFORMITY NOTICE

Operation of the device (the devices) may be affected by strong static, electrical or high-frequency fields (radio installations, mobile telephones, microwaves, electrostatic discharges). If this occurs, try increasing the distance from the devices causing the interference.

FCC STATEMENT

This equipment has been tested and found to comply with the limits for a Class B digital device, pursuant to part 15 of the FCC Rules. These limits are designed to provide reasonable protection against harmful interference in a residential installation. This equipment generates, uses and can radiate radio frequency energy and, if not installed and used in accordance with the instructions, may cause harmful interference to radio communications. However, there is no guarantee that interference will not occur in a particular installation. If this equipment does cause harmful interference to radio or television reception, which can be determined by turning the equipment off and on, the user is encouraged to try to correct the interference by one or more of the following measures:

- Reorient or relocate the receiving antenna.
- Increase the separation between the equipment and receiver.
- Connect the equipment to an outlet on a circuit different from that to which the receiver is connected.
- Consult the dealer or an experienced radio/TV technician for help.

This device complies with part 15 of the FCC rules. Operation is subject to the following two conditions: (1) This device may not cause harmful interference, and (2) this device must accept any interference received, including interference that may cause undesired operation.

Note: Modifications to this product will void the user's authority to operate this equipment.

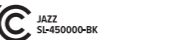

JAZZ SL-450000-BK

CONFORMITY NOTICE KONFORMITÄTSHINWEIS

IMPORTER/MANUFACTURER / IMPORTEUR/HERSTELLER:

Zeifracht Medien GmbH

Im Dorf 5

27404 Heeslingen

GERMANY

Phone / Telefon: (+49) 4287 9244-0

PRODUCT DETAILS / ANGABEN ZUM PRODUKT:

Product no. / Produktnr.: SL-450000-BK

Type description / Typbeschreibung: JAZZ USB CHARGER – for PS4*, black

THE PRODUCT COMPLIES WITH THE FOLLOWING DIRECTIVES / DAS PRODUKT ENTSPRICHT DEN FOLGENDEN RICHTLINIEN:

EMC	2014/30/EU
RoHS	2011/65/EU

For a full declaration of conformity, the latest user guide, FAQ or further information, please visit www.speedlink.com.

Eine vollständige Konformitätserklärung, das aktuelle Benutzerhandbuch, häufig gestellte Fragen und weitere Informationen finden Sie unter www.speedlink.com.



All rights reserved. Speedlink, the Speedlink word mark and the Speedlink swoosh are registered trademarks of Zeifracht GmbH & Co. KGaA. * PlayStation, PS4 and DUALSHOCK are registered trademarks of Sony Computer Entertainment Inc. This product is neither licensed nor endorsed by Sony Computer Entertainment Inc. The Instagram logo is a registered trademark/service mark of Instagram LLC. The Facebook logo is a registered trademark of Facebook Inc. The TikTok logo is a registered trademark of ByteDance. All trademarks are the property of their respective owner. Technical specifications are subject to change. Information contained herein is subject to change without prior notice. Zeifracht Medien GmbH shall not be made liable for any errors that may appear. Please keep this information for later reference.

USER GUIDE JAZZ USB CHARGER

SL-450000-BK // V06P

Speedlink logo

Speedlink logo

Speedlink logo

Speedlink logo

Speedlink logo

Speedlink logo

Speedlink logo

Speedlink logo

Speedlink logo

Speedlink logo

Speedlink logo

Speedlink logo

Speedlink logo

Speedlink logo

Speedlink logo

Speedlink logo

Speedlink logo

Speedlink logo

Speedlink logo

Speedlink logo

Speedlink logo

Speedlink logo

Speedlink logo

Speedlink logo